

# ГЕНЕРАТОРЫ ДЛЯ РЕФРИЖЕРАТОРОВ

**Leece-Neville**



OUTPUT  
V / A

ПРИМЕЧАНИЕ





## CARRIER TRANSICOLD

### > ENGINES

Various Models	80 >>	Mercedes OM636 Diesel	110-629	12V / 37A	
Various Models	80 >>	Perkins 4.108 Diesel	110-629	12V / 37A	
Various Models	All	Kubota CT2-29 (D482) Diesel	110-610RM	12V / 37A	
Various Models	All	CT4-91-TV 1.5L Diesel	110-611RM	12V / 65A	
Various Models	All	Kubota CT4-114 (V1902) Diesel	110-629	12V / 37A	
Various Models	All	Kubota CT4-114 (V1902) Diesel	110-527	12V / 51A	
Various Models	All	Kubota CT4-114 (V1902) Diesel	110-612RM	12V / 65A	Motorola 65A
Various Models	All	Kubota CT4-114 (V1902-DI) Diesel	110-629	12V / 37A	
Various Models	All	Kubota CT4-114 (V1902-DI) Diesel	110-527	12V / 51A	
Various Models	All	Kubota CT4-114 (V1902-DI) Diesel	110-612RM	12V / 65A	
Various Models	All	Kubota CT4-114-TV (V1902-TV) Diesel	110-607RM	12V / 65A	6203 DE Bearing
Various Models	All	Kubota CT4-114-TV (V1902-TV) Diesel	110-609RM	12V / 65A	6303 DE Bearing
Various Models	All	Kubota CT4-134 (V2203) Diesel	110-629	12V / 37A	
Various Models	All	Kubota CT4-134 (V2203-DI) Diesel	110-629	12V / 37A	
Various Models	All	Kubota CT4-134 (V2203-DI) Diesel	110-527	12V / 51A	Motorola 51A (Ext. Reg.)
Various Models	All	Kubota CT4-134 (V2203-DI) Diesel	110-647	12V / 51A	Motorola 51A (Int. Reg.)
Various Models	All	Kubota CT4-134 (V2203-DI) Diesel	110-607RM	12V / 65A	6203 DE Bearing
Various Models	All	Kubota CT4-134 (V2203-DI) Diesel	110-609RM	12V / 65A	6303 DE Bearing
Various Models	All	Kubota CT4-134 (V2203-DI) Diesel	110-612RM	12V / 65A	Motorola 65A (Int. Reg.)
Various Models	All	Kubota CT4-134 (V2203-DI) Diesel	110-608RM	12V / 105A	
Various Models	All	Kubota CT4-134-TV (V2203-TV) Diesel	110-629	12V / 37A	
Various Models	All	Kubota CT4-134-TV (V2203-TV) Diesel	110-527	12V / 51A	Motorola 51A (Ext. Reg.)
Various Models	All	Kubota CT4-134-TV (V2203-TV) Diesel	110-647	12V / 51A	Motorola 51A (Int. Reg.)
Various Models	All	Kubota CT4-134-TV (V2203-TV) Diesel	110-607RM	12V / 65A	Motorola 65A (6203 DE Bearing)
Various Models	All	Kubota CT4-134-TV (V2203-TV) Diesel	110-609RM	12V / 65A	Motorola 65A (6303 DE Bearing)
Various Models	All	Kubota CT4-134-TV (V2203-TV) Diesel	110-611RM	12V / 65A	Motorola 65A Alternator
Various Models	All	Kubota CT4-134-TV (V2203-TV) Diesel	110-612RM	12V / 65A	Motorola 65A Alternator

### > GENERATOR SETS

69GC15	All	Kubota CT4-134 (V2203-DI) Diesel	110-612RM	12V / 65A	
--------	-----	----------------------------------	-----------	-----------	--

				OUTPUT V / A	ПРИМЕЧАНИЕ
69GC15	All	Kubota CT4-114 (V1902) Diesel	110-629	12V / 37A	
69GC15	All	Kubota CT4-114 (V1902) Diesel	110-612RM	12V / 65A	
RG15	All	Kubota CT4-134 (V2203-DI) Diesel	110-612RM	12V / 65A	
UG15	All	Kubota CT4-134 (V2203-DI) Diesel	110-612RM	12V / 65A	
<b>&gt; HEATING UNITS</b>					
Solara	All	Kubota CT2-29 (D482) Diesel	110-610RM	12V / 37A	
<b>&gt; TRAILER UNITS</b>					
Eagle Plus	All	Kubota CT4-134-TV (V2203-TV) Diesel	110-629	12V / 37A	
Eagle Plus	All	Kubota CT4-134-TV (V2203-TV) Diesel	110-527	12V / 51A	Motorola 51A (Ext. Reg.)
Eagle Plus	All	Kubota CT4-134-TV (V2203-TV) Diesel	110-647	12V / 51A	Motorola 51A (Int. Reg.)
Eagle Plus	All	Kubota CT4-134-TV (V2203-TV) Diesel	110-612RM	12V / 65A	
Eagle Plus	All	Kubota CT4-134 (V2203-DI) Diesel	110-629	12V / 37A	
Eagle Plus	All	Kubota CT4-134 (V2203-DI) Diesel	110-527	12V / 51A	Motorola 51A (Ext. Reg.)
Eagle Plus	All	Kubota CT4-134 (V2203-DI) Diesel	110-647	12V / 51A	Motorola 51A (Int. Reg.)
Eagle Plus	All	Kubota CT4-134 (V2203-DI) Diesel	110-612RM	12V / 65A	
Eagle Plus	All	Kubota CT4-134 (V2203) Diesel	110-629	12V / 37A	
Eagle Plus	All	Kubota CT4-114 (V1902-DI) Diesel	110-629	12V / 37A	
Eagle Plus	All	Kubota CT4-114 (V1902-DI) Diesel	110-527	12V / 51A	
Eagle Plus	All	Kubota CT4-114 (V1902-DI) Diesel	110-612RM	12V / 65A	
Eagle Plus	All	Kubota CT4-114 (V1902) Diesel	110-629	12V / 37A	
Eagle Plus	All	Kubota CT4-114 (V1902) Diesel	110-527	12V / 51A	
Eagle Plus	All	Kubota CT4-114 (V1902) Diesel	110-612RM	12V / 65A	
Europhoenix	All	Kubota CT4-114 (V1902) Diesel	110-611RM	12V / 65A	
Extra	All	Kubota CT4-134-TV (V2203-TV) Diesel	110-607RM	12V / 65A	
Extra	All	Kubota CT4-134-TV (V2203-TV) Diesel	110-609RM	12V / 65A	
Extra	All	Kubota CT4-114-TV (V1902-TV) Diesel	110-607RM	12V / 65A	
Extra	All	Kubota CT4-114-TV (V1902-TV) Diesel	110-609RM	12V / 65A	
Genesis TM900	All	Kubota CT4-134 (V2203-DI) Diesel	110-607RM	12V / 65A	6203 DE Bearing
Genesis TM900	All	Kubota CT4-134 (V2203-DI) Diesel	110-609RM	12V / 65A	6303 DE Bearing
Genesis TM900	All	Kubota CT4-134 (V2203-DI) Diesel	110-608RM	12V / 105A	
Genesis TM1000	All	Kubota CT4-134 (V2203-DI) Diesel	110-607RM	12V / 65A	6203 DE Bearing

# ГЕНЕРАТОРЫ ДЛЯ РЕФРИЖЕРАТОРОВ

**Leece-Neville**







OUTPUT  
V / A

ПРИМЕЧАНИЕ

## CARRIER TRANSICOLD

### > TRAILER UNITS

Genesis TM1000	All	Kubota CT4-134 (V2203-DI) Diesel	110-609RM	12V / 65A	6303 DE Bearing
Genesis TM1000	All	Kubota CT4-134 (V2203-DI) Diesel	110-608RM	12V / 105A	
Genesis TR100	All	Kubota CT4-134-TV (V2203-TV) Diesel	110-607RM	12V / 65A	6203 DE Bearing
Genesis TR100	All	Kubota CT4-134-TV (V2203-TV) Diesel	110-609RM	12V / 65A	6303 DE Bearing
NDB40	All	Perkins 4.108 Diesel	110-629	12V / 37A	
NDE40	All	Perkins 4.108 Diesel	110-629	12V / 37A	
NDF40	All	Kubota CT4-114 (V1902) Diesel	110-629	12V / 37A	
NDJ40	All	Kubota CT4-114 (V1902) Diesel	110-629	12V / 37A	
NDJ40	All	Perkins 4.108 Diesel	110-629	12V / 37A	
NDS40	All	Kubota CT4-114 (V1902) Diesel	110-527	12V / 51A	
NDS40	All	Perkins 4.108 Diesel	110-629	12V / 37A	
NDT40	All	Perkins 4.108 Diesel	110-629	12V / 37A	
Optima	All	CT4-91-TV 1.5L Diesel	110-611RM	12V / 65A	Motorola 65A Alternator
Phoenix Advantage	All		110-629	12V / 37A	
Phoenix Advantage	All		110-527	12V / 51A	
Phoenix Advantage	All		110-612RM	12V / 65A	Motorola 65A Alternator
Phoenix Ultra	All	Kubota CT4-134 (V2203-DI) Diesel	110-608RM	12V / 105A	
Phoenix Ultra	All	Kubota CT4-134-TV (V2203-TV) Diesel	110-611RM	12V / 65A	Motorola 65A Alternator
Phoenix Ultra XL	All	Kubota CT4-134 (V2203-DI) Diesel	110-607RM	12V / 65A	Models NDA93M, 94M (Small Brg)
Phoenix Ultra XL	All	Kubota CT4-134 (V2203-DI) Diesel	110-609RM	12V / 65A	Models NDA93M, 94M (Large Brg)
Phoenix Ultra XL	All	Kubota CT4-134 (V2203-DI) Diesel	110-611RM	12V / 65A	Motorola 65A Alternator
Thunderbird	All	Kubota CT4-114 (V1902) Diesel	110-629	12V / 37A	
Thunderbird	All	Kubota CT4-114 (V1902) Diesel	110-527	12V / 51A	
Thunderbird	All	Kubota CT4-114 (V1902) Diesel	110-612RM	12V / 65A	
Thunderbird	All	Kubota CT4-114 (V1902-DI) Diesel	110-629	12V / 37A	
Thunderbird	All	Kubota CT4-114 (V1902-DI) Diesel	110-527	12V / 51A	
Thunderbird	All	Kubota CT4-114 (V1902-DI) Diesel	110-612RM	12V / 65A	
UDE Series	All	Kubota CT4-114 (V1902) Diesel	110-629	12V / 37A	
UDE Series	All	Mercedes OM636 Diesel	110-629	12V / 37A	
UDE Series	All	Perkins 4.108 Diesel	110-629	12V / 37A	
UDG Series	All	Kubota CT4-114 (V1902) Diesel	110-629	12V / 37A	

				OUTPUT V / A	ПРИМЕЧАНИЕ
UDG Series	All	Kubota CT4-114 (V1902) Diesel	110-527	12V / 51A	
UDG Series	All	Mercedes OM636 Diesel	110-629	12V / 37A	
Ultima 53	All	Kubota CT4-134 (V2203-DI) Diesel	110-607RM	12V / 65A	6203 DE Bearing
Ultima 53	All	Kubota CT4-134 (V2203-DI) Diesel	110-609RM	12V / 65A	6303 DE Bearing
<b>&gt; TRUCK UNITS</b>					
Silverhawk Magnum	All	Kubota CT3-52 (ZB600) Diesel	110-629	12V / 37A	
Silverhawk Plus	All	Kubota CT3-52 (ZB600) Diesel	110-629	12V / 37A	
TDB	All	Kubota CT3-52 (ZB600) Diesel	110-629	12V / 37A	
TDS	All	Kubota CT3-52 (ZB600) Diesel	110-629	12V / 37A	
<b>THERMO KING</b>					
<b>&gt; BATTERYLESS SYSTEMS</b>					
Bus A/C Units		With 24V Electrical Systems	110-575	24V / 150A	24V Excitation
Bus A/C Units		With 12V Electrical Systems	110-576	24V / 150A	12V Excitation
Bus A/C Units		With 12V Electrical Systems	110-555JHO	12V / 160A	
<b>&gt; TRAILER UNITS</b>					
HK, HK-II, HK-III	92 >>	TK 2.49 Diesel	110-581	12V / 23A	
HK, HK-II, HK-III	92 >>	TK 2.49 Diesel	110-600	12V / 65A	
HK-30	80-88	TK 2.44 Diesel	110-699	12V / 37A	
HK-30	89 >>	TK 2.44 Diesel	110-699	12V / 37A	
HK-30	80-88	TK 2.44 Diesel	110-600	12V / 65A	
HK-30	89 >>	TK 2.44 Diesel	110-600	12V / 65A	
HK-60	80-88	TK 2.44 Diesel	110-699	12V / 37A	
HK-60	89 >>	TK 2.44 Diesel	110-699	12V / 37A	
HK-60	80-88	TK 2.44 Diesel	110-600	12V / 65A	
HK-60	89 >>	TK 2.44 Diesel	110-600	12V / 65A	
HK-100	80-88	TK 2.44 Diesel	110-699	12V / 37A	
HK-100	89 >>	TK 2.44 Diesel	110-699	12V / 37A	
HK-100	80-88	TK 2.44 Diesel	110-600	12V / 65A	
HK-100	89 >>	TK 2.44 Diesel	110-600	12V / 65A	
LND 30	83 >>	Yanmar 353 (TK 3.53) Diesel	110-159	12V / 37A	
LND 30	83 >>	Yanmar 353 (TK 3.53) Diesel	110-543	12V / 51A	
LND 50	91 >>	Yanmar 353 (TK 3.53) Diesel	66021606	12V / 65A	
SB-190	99 >>	Isuzu 2.2L (TK DI2.2, -SE) Diesel	66021606	12V / 65A	Bosch 37A / 65A
SB-200	99 >>	Yanmar 486 (TK 4.86) Diesel	66021606	12V / 65A	Bosch 37A / 65A
SB-210	99 >>	Yanmar 486 (TK 4.86) Diesel	66021606	12V / 65A	Bosch 37A / 65A

# ГЕНЕРАТОРЫ ДЛЯ РЕФРИЖЕРАТОРОВ

**Leece-Neville**







OUTPUT  
V / A

ПРИМЕЧАНИЕ

## THERMO KING

### > TRAILER UNITS

SB-300	99 >>	Yanmar 486 (TK 4.86) Diesel	66021606	12V / 65A	Bosch 37A / 65A
SB-310	99 >>	Yanmar 486 (TK 4.86) Diesel	66021606	12V / 65A	Bosch 37A / 65A
SB-I	74-81	Isuzu 2.2L (TK DI2.2, -SE) Diesel	110-543	12V / 51A	Motorola 37A / 51A
SB-II	80 >>	Isuzu 2.2L (TK DI2.2, -SE) Diesel	110-543	12V / 51A	
SB-II	80 >>	Isuzu 2.2L (TK DI2.2, -SE) Diesel	110-159	12V / 37A	
SB-II	80 >>	Isuzu 2.2L (TK DI2.2, -SE) Diesel	110-543	12V / 51A	
SB-II	80 >>	Isuzu 2.0L (TK C201) Diesel	110-159	12V / 37A	
SB-II	80 >>	Isuzu 2.0L (TK C201) Diesel	110-543	12V / 51A	
SB-II	84 >>	Isuzu 2.2L (TK DI2.2, -SE) Diesel	110-699	12V / 37A	
SB-II	84 >>	Isuzu 2.2L (TK DI2.2, -SE) Diesel	110-600	12V / 65A	
SB-II	84 >>	Isuzu 2.0L (TK C201) Diesel	110-699	12V / 37A	
SB-II	84 >>	Isuzu 2.0L (TK C201) Diesel	110-600	12V / 65A	
SB-II	89 >>	Isuzu 2.2L (TK DI2.2, -SE) Diesel	110-699	12V / 37A	
SB-II	89 >>	Isuzu 2.2L (TK DI2.2, -SE) Diesel	110-600	12V / 65A	
SB-II	89 >>	Isuzu 2.0L (TK C201) Diesel	110-699	12V / 37A	
SB-II	89 >>	Isuzu 2.0L (TK C201) Diesel	110-600	12V / 65A	
SB-II	91 >>	Isuzu 2.2L (TK DI2.2, -SE) Diesel	66021606	12V / 65A	Bosch 37A / 65A
SB-II	91 >>	Isuzu 2.0L (TK C201) Diesel	66021606	12V / 65A	Bosch 37A / 65A
SB-II MAX	91 >>	Isuzu 2.2L (TK DI2.2, -SE) Diesel	66021606	12V / 65A	Bosch 37A / 65A
SB-II SR	91 >>	Isuzu 2.2L (TK DI2.2, -SE) Diesel	66021606	12V / 65A	Bosch 37A / 65A
SB-II SR	98 >>	Yanmar 486 (TK 4.86) Diesel	66021606	12V / 65A	Bosch 37A / 65A
SB-III	80-89	Isuzu 2.2L (TK DI2.2, -SE) Diesel	110-543	12V / 51A	
SB-III	80-89	Isuzu 2.0L (TK C201) Diesel	110-543	12V / 51A	
SB-III	90 >>	Isuzu 2.2L (TK DI2.2, -SE) Diesel	110-581	12V / 23A	
SB-III	90 >>	Isuzu 2.0L (TK C201) Diesel	110-581	12V / 23A	
SB-III MAX	91 >>	Isuzu 2.2L (TK DI2.2, -SE) Diesel	66021606	12V / 65A	Bosch 37A / 65A
SB-III MAX	91 >>	Isuzu 2.0L (TK C201) Diesel	66021606	12V / 65A	Bosch 37A / 65A
SB-III SR	93 >>	Isuzu 2.2L (TK DI2.2, -SE) Diesel	66021606	12V / 65A	Bosch 37A / 65A
SB-III SR	99 >>	Yanmar 486 (TK 4.86) Diesel	20140111	12V / 120A	
SB-III SR	99 >>	Yanmar 486 (TK 4.86) Diesel	66021606	12V / 65A	Bosch 37A / 65A
SDZ	91 >>	Kubota Z400 Diesel	66021606	12V / 65A	Bosch 37A / 65A
SDZ	91 >>		66021606	12V / 65A	Bosch 37A / 65A
Sentry	85 >>	Isuzu 2.0L (TK C201) Diesel	110-159	12V / 37A	

				OUTPUT V / A	ПРИМЕЧАНИЕ
Sentry	85 >>	Isuzu 2.0L (TK C201) Diesel	110-543	12V / 51A	
Sentry	89 >>	Isuzu 2.2L (TK DI2.2, -SE) Diesel	110-581	12V / 23A	
Sentry	85 >>	Isuzu 2.2L (TK DI2.2, -SE) Diesel	110-159	12V / 37A	
Sentry	85 >>	Isuzu 2.2L (TK DI2.2, -SE) Diesel	110-543	12V / 51A	
Sentry	91 >>	Isuzu 2.2L (TK DI2.2, -SE) Diesel	66021606	12V / 65A	Bosch 37A / 65A
Sentry	89 >>	Isuzu 2.2L (TK DI2.2, -SE) Diesel	110-600	12V / 65A	Motorola 65A (Int. Reg.)
SL100	96 >>	Yanmar 482 / 486 (TK 4.82 / 4.86)	66021606	12V / 65A	Bosch 37A / 65A
SL100e	02 >>	Yanmar 486 (TK 4.86) Diesel	66021606	12V / 65A	Bosch 37A / 65A
SL200	96 >>	Yanmar 482 / 486 (TK 4.82 / 4.86)	66021606	12V / 65A	Bosch 37A / 65A
SL200e	02 >>	Yanmar 486 (TK 4.86) Diesel	66021606	12V / 65A	Bosch 37A / 65A
SL300	96 >>	Yanmar 482 / 486 (TK 4.82 / 4.86)	66021606	12V / 65A	Bosch 37A / 65A
SL400	96 >>	Yanmar 482 / 486 (TK 4.82 / 4.86)	66021606	12V / 65A	Bosch 37A / 65A
SL400 SR2	02 >>	Yanmar 486 (TK 4.86) Diesel	66021606	12V / 65A	Bosch 37A / 65A
SL400e	02 >>	Yanmar 486 (TK 4.86) Diesel	66021606	12V / 65A	Bosch 37A / 65A
SMX	91 >>		66021606	12V / 65A	Bosch 37A / 65A
SMX II	91 >>		66021606	12V / 65A	Bosch 37A / 65A
SMX SR	91 >>		66021606	12V / 65A	Bosch 37A / 65A
SNWD	74 >>		110-159	12V / 37A	
SNWD	74 >>		110-543	12V / 51A	
Super II	83 >>	Isuzu 2.2L (TK DI2.2, -SE) Diesel	110-699	12V / 37A	
Super II	83 >>	Isuzu 2.2L (TK DI2.2, -SE) Diesel	110-600	12V / 65A	
Super II	83 >>	Isuzu 2.0L (TK C201) Diesel	110-699	12V / 37A	
Super II	83 >>	Isuzu 2.0L (TK C201) Diesel	110-600	12V / 65A	
Super II	89 >>	Isuzu 2.2L (TK DI2.2, -SE) Diesel	110-699	12V / 37A	
Super II	89 >>	Isuzu 2.2L (TK DI2.2, -SE) Diesel	110-600	12V / 65A	
Super II	89 >>	Isuzu 2.0L (TK C201) Diesel	110-699	12V / 37A	
Super II	91 >>	Isuzu 2.2L (TK DI2.2, -SE) Diesel	66021606	12V / 65A	Bosch 37A / 65A
Super II MAX	89 >>	Isuzu 2.2L (TK DI2.2, -SE) Diesel	110-581	12V / 23A	
Super II MAX	89 >>	Isuzu 2.2L (TK DI2.2, -SE) Diesel	110-699	12V / 37A	
Super II MAX	89 >>	Isuzu 2.2L (TK DI2.2, -SE) Diesel	110-600	12V / 65A	
Super II SR	91 >>	Isuzu 2.2L (TK DI2.2, -SE) Diesel	66021606	12V / 65A	
Super II SR	91 >>	Isuzu 2.2L (TK DI2.2, -SE) Diesel	66021606	12V / 65A	
Super II TC	91 >>	Isuzu 2.2L (TK DI2.2, -SE) Diesel	66021606	12V / 65A	Bosch 37A / 65A
Super II TC	99 >>	Yanmar 486 (TK 4.86) Diesel	20140111	12V / 120A	
Super II TC	99 >>	Yanmar 486 (TK 4.86) Diesel	66021606	12V / 65A	Bosch 37A / 65A



# ГЕНЕРАТОРЫ ДЛЯ РЕФРИЖЕРАТОРОВ

**Leece-Neville**



OUTPUT  
V / A

ПРИМЕЧАНИЕ





## THERMO KING

### > TRAILER UNITS





Super NWD	84 >>	Isuzu 2.2L (TK DI2.2, -SE) Diesel	110-159	12V / 37A	
Super NWD	84 >>	Isuzu 2.2L (TK DI2.2, -SE) Diesel	110-543	12V / 51A	Motorola 37A / 51A
Super NWD	84 >>	Isuzu 2.0L (TK C201) Diesel	110-159	12V / 37A	
Super NWD	84 >>	Isuzu 2.0L (TK C201) Diesel	110-543	12V / 51A	Motorola 37A / 51A
TD-I	80 >>	Isuzu 2.2L (TK DI2.2, -SE) Diesel	110-159	12V / 37A	
TD-I	80 >>	Isuzu 2.2L (TK DI2.2, -SE) Diesel	110-543	12V / 51A	
TD-II	80 >>	Isuzu 2.2L (TK DI2.2, -SE) Diesel	110-159	12V / 37A	
TD-II	80 >>	Isuzu 2.2L (TK DI2.2, -SE) Diesel	110-543	12V / 51A	
TD-II	89 >>	Yanmar 388 (TK 3.88) Diesel	110-581	12V / 23A	
TD-II	89 >>	Yanmar 388 (TK 3.88) Diesel	110-600	12V / 65A	
URD	96 >>	Yanmar 353 (TK 3.53) Diesel	110-521	12V / 72A	
URD	96 >>	Yanmar 353 (TK 3.53) Diesel	66021624	12V / 90A	Bosch 90A Alt
URD	96 >>	Yanmar 353 (TK 3.53) Diesel	110-639RM	12V / 90A	Motorola 90A Alt
URD-III MAX	96 >>	Yanmar 395 (TK 3.95) Diesel	110-639RM	12V / 90A	





### > TRUCK UNITS





KD-I	78 >>	Yanmar 235 (TK 2.35) Diesel	110-159	12V / 37A	
KD-I	78 >>	Yanmar 235 (TK 2.35) Diesel	110-543	12V / 51A	
KD-II	89 >>	Yanmar 366 (TK 3.66) Diesel	110-581	12V / 23A	
KD-II MAX	89 >>	Yanmar 366 (TK 3.66) Diesel	110-581	12V / 23A	
KD-II SR	89 >>	Yanmar 374 (TK 3.74) Diesel	110-581	12V / 23A	
MD-200		Yanmar 374 (TK 3.74) Diesel	110-581	12V / 23A	
MD-200-MT		Yanmar 374 (TK 3.74) Diesel	110-581	12V / 23A	
MD-300		Yanmar 374 (TK 3.74) Diesel	110-581	12V / 23A	
MD-I	83 >>	Yanmar 235 (TK 2.35) Diesel	110-159	12V / 37A	
MD-I	83 >>	Yanmar 235 (TK 2.35) Diesel	110-543	12V / 51A	
MD-II	89 >>	Yanmar 366 (TK 3.66) Diesel	110-581	12V / 23A	
MD-II MAX	89 >>	Yanmar 374 (TK 3.74) Diesel	110-581	12V / 23A	
MD-II MAX SR	89 >>	Yanmar 374 (TK 3.74) Diesel	110-581	12V / 23A	
MD-II SR	89 >>	Yanmar 374 (TK 3.74) Diesel	110-581	12V / 23A	
MD-II TCI	89 >>	Yanmar 366 (TK 3.66) Diesel	110-581	12V / 23A	
MD-II TCI	89 >>	Yanmar 366 (TK 3.66) Diesel	110-699	12V / 37A	
MD-II TCI	89 >>	Yanmar 366 (TK 3.66) Diesel	110-636RM	12V / 65A	
NWD Series	74 >>	Isuzu 2.0L (TK C201) Diesel	110-159	12V / 37A	



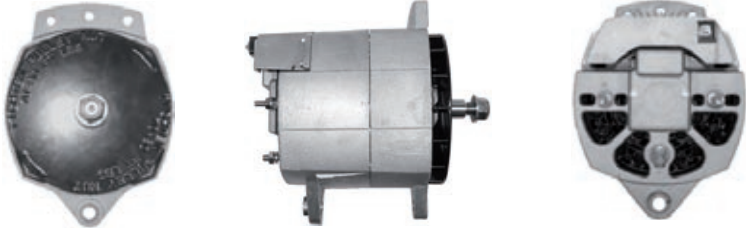

				OUTPUT V / A	ПРИМЕЧАНИЕ
NWD Series	74 >>	Isuzu 2.0L (TK C201) Diesel	110-543	12V / 51A	Motorola 37A / 51A
RD-I	80 >>	Yanmar 235 (TK 2.35) Diesel	110-159	12V / 37A	
RD-I	80 >>	Yanmar 235 (TK 2.35) Diesel	110-543	12V / 51A	
RD-II	92 >>	Yanmar 388 (TK 3.88) Diesel	110-581	12V / 23A	
RD-II	92 >>	Yanmar 388 (TK 3.88) Diesel	110-699	12V / 37A	
RD-II	92 >>	Yanmar 388 (TK 3.88) Diesel	110-600	12V / 65A	
RD-II MAX	92 >>	Yanmar 388 (TK 3.88) Diesel	110-581	12V / 23A	
RD-II MAX	92 >>	Yanmar 388 (TK 3.88) Diesel	110-699	12V / 37A	
RD-II MAX	92 >>	Yanmar 388 (TK 3.88) Diesel	110-600	12V / 65A	
RD-II MAX SR	92 >>	Yanmar 388 (TK 3.88) Diesel	110-581	12V / 23A	
RD-II MAX SR	92 >>	Yanmar 388 (TK 3.88) Diesel	110-699	12V / 37A	
RD-II MAX SR	92 >>	Yanmar 388 (TK 3.88) Diesel	110-600	12V / 65A	
RD-II TCI	92 >>	Yanmar 388 (TK 3.88) Diesel	110-699	12V / 37A	
RD-II TCI-Z			110-699	12V / 37A	
RD-II TCI-Z			110-600	12V / 65A	
RD-II TCI-Z			66021624	12V / 90A	
RD-II TLE	96 >>	Yanmar 395 (TK 3.95) Diesel	110-699	12V / 37A	
RD-II TLE	96 >>	Yanmar 395 (TK 3.95) Diesel	110-638RM	12V / 90A	
TS Spectrum	02 >>	TK 3.76 Diesel	110-638RM	12V / 90A	
TS-200	00 >>	Yanmar 374 (TK 3.74) Diesel	110-581	12V / 23A	
TS-200	00 >>	Yanmar 374 (TK 3.74) Diesel	110-635RM	12V / 37A	
TS-300	00 >>	Yanmar 374 (TK 3.74) Diesel	110-581	12V / 23A	
TS-300	00 >>	Yanmar 374 (TK 3.74) Diesel	110-635RM	12V / 37A	
TS-500	00 >>	Yanmar 395 (TK 3.95) Diesel	110-581	12V / 23A	
TS-500	00 >>	Yanmar 395 (TK 3.95) Diesel	110-635RM	12V / 37A	
TS-600	00 >>	Yanmar 395 (TK 3.95) Diesel	110-581	12V / 23A	
TS-600	00 >>	Yanmar 395 (TK 3.95) Diesel	110-635RM	12V / 37A	
UTS		Yanmar 395 (TK 3.95) Diesel	110-639RM	12V / 90A	
XDS	99 >>		110-581	12V / 23A	
<b>ZANOTTI</b>					
<b>&gt; TRAILER UNIT</b>					
T620	All	Lombardini	20110326	12V / 65A	







<b>20110326</b>	12V	65A	ER	17mm	Clockwise	4K, 59.7mm	
							<b>ZANOTTI</b> > TRAILER UNIT - T620
<b>20140111</b>	12V	120A	IR	17mm	Clockwise	None	
							<b>THERMO KING</b> > TRAILER UNIT - SB-III SR, Super II TC
<b>66021606</b>	12V	65A	IR	17mm	Bi-directional	None	
							<b>THERMO KING</b> > TRAILER UNIT - LND 50, SB, SB-II, SB-III, SDZ, Sentry, SL, SMX, Super II Series
<b>66021624</b>	12V	90A	IR	17mm	Bi-directional	None	
							<b>THERMO KING</b> > TRAILER UNIT - URD > TRUCK UNIT - RD-II TCI-Z
<b>110-159</b>	12V	37A	IR	5/8"	Clockwise	None	
							<b>THERMO KING</b> > TRAILER UNIT - LND 30, SB-II, Sentry, SNWD, Super NWD, TD-I, TD-II > TRUCK UNIT - KD-I, MD-I, RD-I & NWD Series

<b>110-521</b>	12V	72A	IR	5/8"	Bi-directional	None	<b>THERMO KING</b> > TRAILER UNIT - URD
							
<b>110-527</b>	12V	51A	IR	5/8"	Bi-directional (No fan supplied)	None	<b>CARRIER TRANSICOLD</b> > ENGINES - Various Models > TRAILER UNIT - Eagle Plus, NDS40, Phoenix Advantage, Thunderbird, UDG Series
							
<b>110-543</b>	12V	51A	IR	5/8"	Clockwise	None	<b>THERMO KING</b> > TRAILER UNIT - LND 30, SB-I, SB-II, SB-III, Sentry, SNWD, Super NWD, TD-I, TD-II > TRUCK UNIT - KD-I, MD-I, RD-I & NWD Series
							
<b>110-555JHO</b>	12V	160A	IR	7/8"	Clockwise	None	<b>THERMO KING</b> > BATTERYLESS SYSTEMS - Bus A/C Units
							
<b>110-575</b>	24V	150A	IR	7/8"	Clockwise	None	<b>THERMO KING</b> > BATTERYLESS SYSTEMS - Bus A/C Units
							

<b>110-576</b>	24V	150A	IR	7/8"	Clockwise	None	
							<b>THERMO KING</b> > BATTERYLESS SYSTEMS - Bus A/C Units
<b>110-581</b>	12V	23A	IR	5/8"	Bi-directional	None	
							<b>THERMO KING</b> > TRAILER UNIT - HK, HK-II, HK-III, SB-III, Sentry, Super II MAX, TD-II > TRUCK UNIT - KD-II / SR / MAX, MD-200 / MT, MD-300, MD-II / MAX / MAX SR / SR / TCI, RD-II / MAX / MAX SR, TS-200 / 300 / 500 / 600, XDS
<b>110-600</b>	12V	65A	IR	5/8"	Clockwise	None	
							<b>THERMO KING</b> > TRAILER UNIT - HK, HK-II, HK-III, HK-30 / 60 / 100, SB-II, Sentry, Super II / MAX, TD-II > TRUCK UNIT - RD-II / MAX / MAX SR / TCI-Z
<b>110-607RM</b>	12V	65A	IR	5/8"	Counter Clockwise	None	
							<b>CARRIER TRANSICOLD</b> > ENGINES - Various Models > TRAILER UNIT - Extra, Genesis TM900 / TM 1000 / TR100, Phoenix Ultra XL, Optima 53
<b>110-608RM</b>	12V	105A	IR	5/8"	Counter Clockwise	None	
							<b>CARRIER TRANSICOLD</b> > ENGINES - Various Models > TRAILER UNIT - Genesis TM900 / TM1000, Phoenix Ultra

<b>110-609RM</b>	12V	65A	IR	5/8"	Clockwise	None	<p><b>CARRIER TRANSICOLD</b></p> <ul style="list-style-type: none"> <li>&gt; ENGINES - Various Models</li> <li>&gt; TRAILER UNIT - Extra, Genesis TM900 / TM1000/ TR100, Phoenix Ultra XL, Ultima 53</li> </ul>
							
<b>110-610RM</b>	12V	37A	IR	5/8"	Clockwise	None	<p><b>CARRIER TRANSICOLD</b></p> <ul style="list-style-type: none"> <li>&gt; ENGINES - Various Models</li> <li>&gt; HEATING UNIT - Solara</li> </ul>
							
<b>110-611RM</b>	12V	65A	IR	5/8"	Bi-directional (No fan supplied)	None	<p><b>CARRIER TRANSICOLD</b></p> <ul style="list-style-type: none"> <li>&gt; ENGINES - Various Models</li> <li>&gt; TRAILER UNIT - Europhoenix, Optima, Phoenix Ultra / XL</li> </ul>
							
<b>110-612RM</b>	12V	65A	IR	5/8"	Bi-directional	None	<p><b>CARRIER TRANSICOLD</b></p> <ul style="list-style-type: none"> <li>&gt; ENGINES - Various Models</li> <li>&gt; GENERATOR SET - 69GC15, RG15, UG15</li> <li>&gt; TRAILER UNIT - Eagle Plus, Phoenix Advantage, Thunderbird</li> </ul>
							
<b>110-629</b>	12V	37A	IR	5/8"	Clockwise	None	<p><b>CARRIER TRANSICOLD</b></p> <ul style="list-style-type: none"> <li>&gt; ENGINES - Various Models</li> <li>&gt; GENERATOR SET - 69GC15</li> <li>&gt; TRAILER UNIT - Eagle Plus, NDB40, NDE40, NDF40, NDJ40, NDS40, NDT40, Phoenix Advantage, Thunderbird, UDE, UDG Series</li> <li>&gt; TRUCK UNIT - Silverhawk Magnum / Plus, TDB, TDS</li> </ul>
							



<b>110-635RM</b>	12V	37A	IR	5/8"	Clockwise	None	<b>THERMO KING</b> > TRUCK UNIT - TS-200 / 300 / 500 / 600
							
<b>110-636RM</b>	12V	65A	IR	5/8"	Clockwise	None	<b>THERMO KING</b> > TRUCK UNIT - MD-II TCI
							
<b>110-638RM</b>	12V	90A	IR	5/8"	Bi-directional	None	<b>THERMO KING</b> > TRUCK UNIT - RD-II TLE, TS Spectrum
							
<b>110-639RM</b>	12V	90A	IR	5/8"	Bi-directional	None	<b>THERMO KING</b> > TRAILER UNIT - URD, URD-III MAX > TRUCK UNIT - UTS
							
<b>110-647</b>	12V	51A	IR	5/8"	Clockwise	None	<b>CARRIER TRANSICOLD</b> > ENGINES - Various Models > TRAILER UNIT - Eagle Plus
							

110-699	12V	37A	IR	5/8"	Clockwise	None	<p><b>THERMO KING</b>            &gt; TRAILER UNIT - HK-30 / 60 / 100, SB-II, Super II / MAX            &gt; TRUCK UNIT - MD-II TCI, RD-II / MAX / MAX SR / TCI/ TCI-Z / TLE</p>
							